

Decorative Precast Walls & Fencing

STACKWALL



THE STACKWALL COLLECTION

Handmade in California, USA - Since 1997



Introduction

I'm often asked what is a StackWall? The short answer is security with style. The long answer is a post & panel wall system in which we stack decorative panels on top of one another, until it creates a secure, element resistant wall.

Cost versus value goes a long way with any wall & fence system one chooses. You may not have even known precast fencing was an option until now. This is not to say we are any better or worse than our competition. Nor are we any less expensive. The adage you get what you pay for is the key. We take pride in our custom concrete blend & rustproof rebar skeletal system, making our walls last a lifetime, enhancing your property value as well.

Our handmade walls are derived from precast concrete & professionally set in decorative molds (with over 100 designs to choose from). No block wall, iron, or vinyl fence can offer this much variety.

The StackWall Collection is comprised of several styles to choose from - That being Stone, Brick, Wood, Elaborate, Modern, and Picket. Feel free to design the perfect wall to match your home or business. Get creative & mix & match from our multitude of panels, colors, toppers & lattices. Once you purchase a StackWall, you'll be happy you did... & your neighbors will want one too.

The true beauty of a StackWall is that the choice is yours.



Chris Manko (CEO - StackWall)

FACTS THAT MATTER



Mountain Ledge (White)

- Fire Resistant (1-2 Hour Fire Rating)
- Wind-Loads of 115 MPH & Up
- Security, Privacy & Noise Reduction
- 10 Year Guarantee
- Fencing & Walls
- Over 100 Designs & Colors to Choose From
- Affordable Alternative to Block Wall
- Seismic Stability
- No Rust, Fiberglass Rebar Reinforced
- Nationwide Shipping
- Customizable Height Ranging from 2 ft - 25 ft

STACK WALL



Bedrock (Buff)

THE
STACK WALL
COLLECTION

STONE

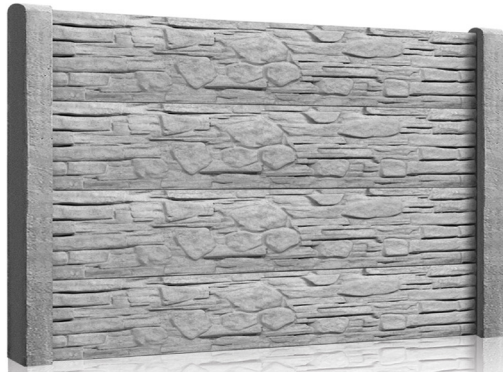

COBBLESTONE
(SKU# S-004)

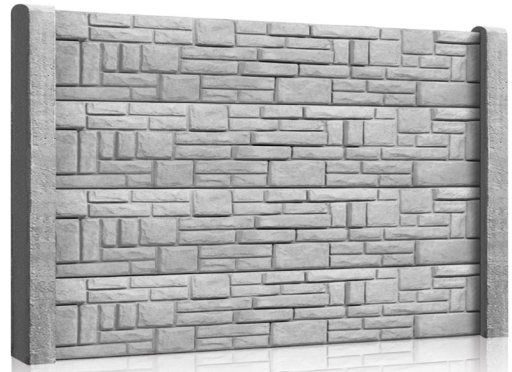

SANTA BARBARA
(SKU# S-007)



TURTLE
(SKU# S-008)

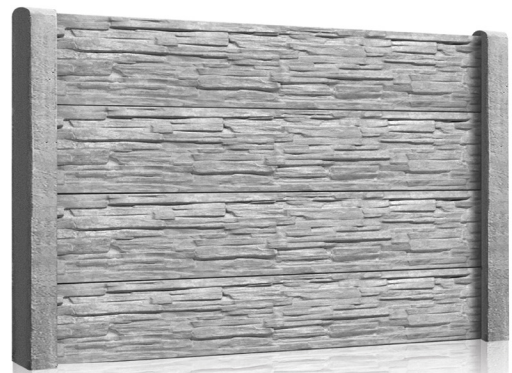

MT. LEDGE
(SKU# S-010)



BEDROCK
(SKU# S-014)



PEBBLE BEACH
(SKU# S-018)

COLORS



Natural



White



Charcoal



Buff



Toffee



Brown



Earth



Red



THE

STACK WALL

COLLECTION

Knotted / Weave Lattice (Toffee)

WOOD

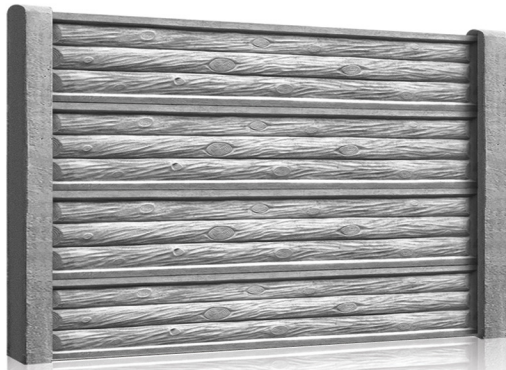

LOG CABIN
(SKU# W-001)

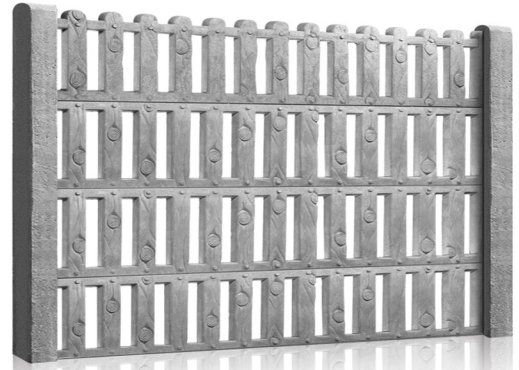

RIVET
(SKU# W-002)

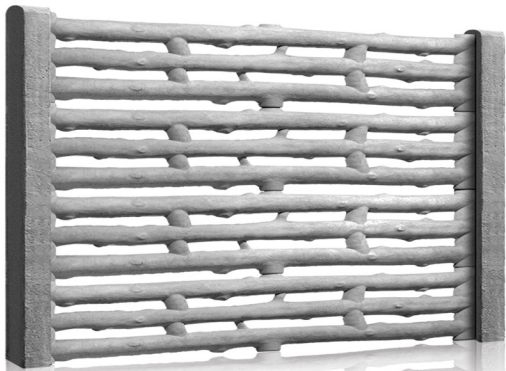

CONTRYSIDE
(SKU# W-003)

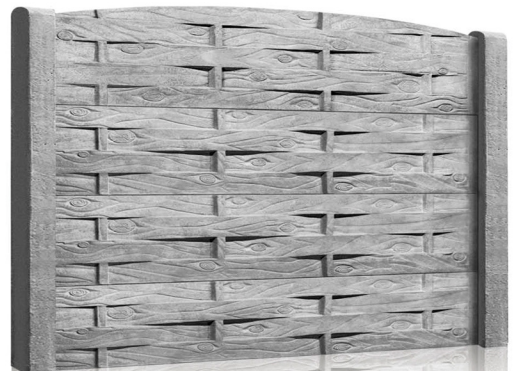

WOVEN
(SKU# W-007)

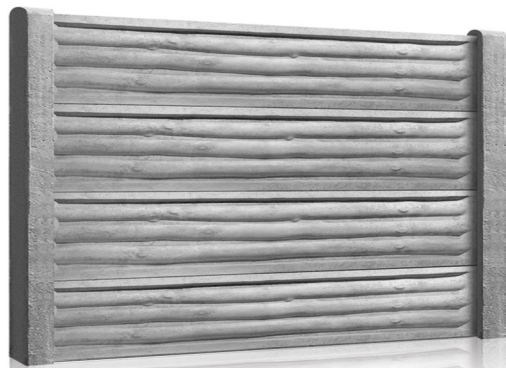

COLONIAL
(SKU# W-005)

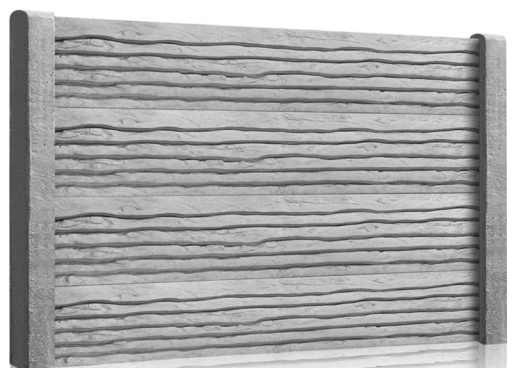

KNOTTED
(SKU# W-006)

COLORS





THE

STACK WALL

COLLECTION

Smooth (White) / Cap Flat (Onyx)

— MODERN —

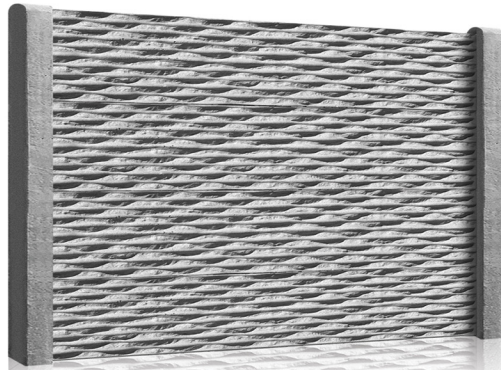

CASCADE
(SKU # M-007)

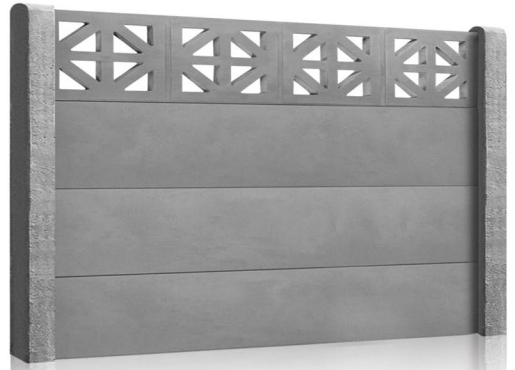

BREEZE BLOCK
(SKU# M-012)

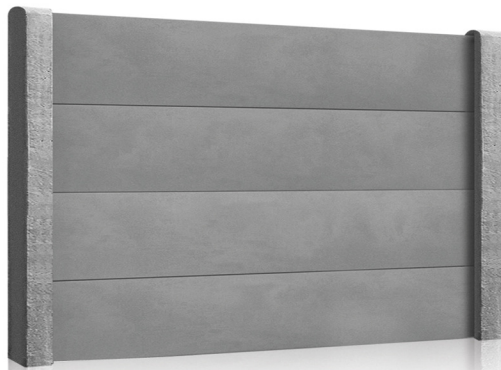

SMOOTH
(SKU# M-003)

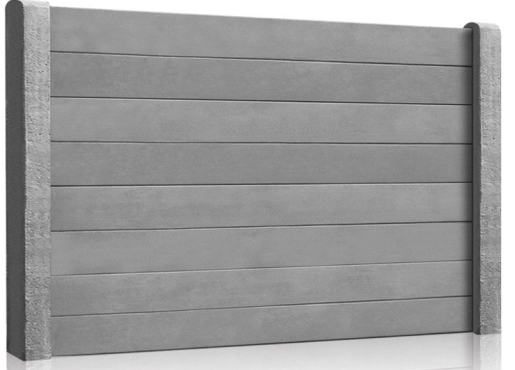

HORIZON
(SKU# M-004)

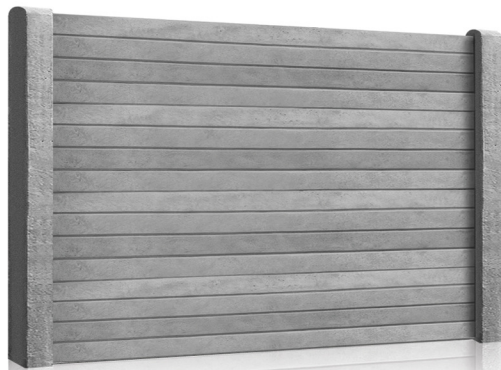

PARALLEL
(SKU# M-005)



CORRUGATED
(SKU# M-006)

COLORS



Natural



White



Charcoal



Buff



Toffee



Brown



Earth



Red



THE
STACK WALL
COLLECTION

Beaded (Red)

BRICK

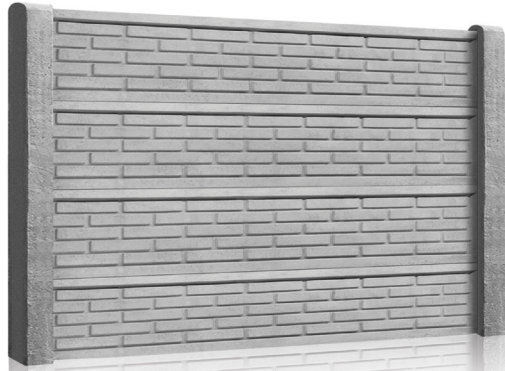

WRIGLEY
(SKU# B-007)



BRICK FRAME
(SKU# B-008)



PORTO
(SKU# B-009)

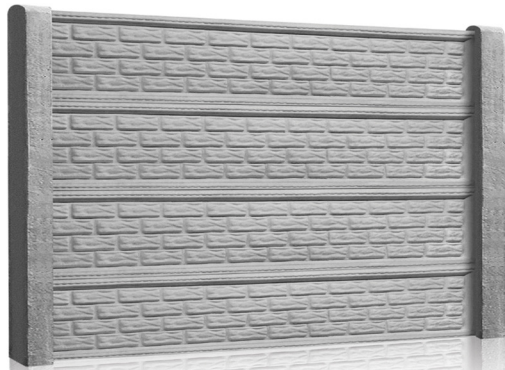

BEADED
(SKU# B-010)

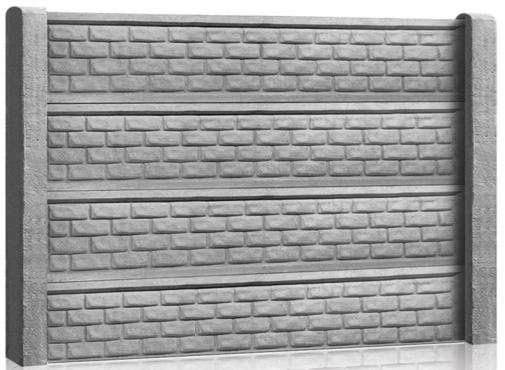

TUMBLED
(SKU# B-018)

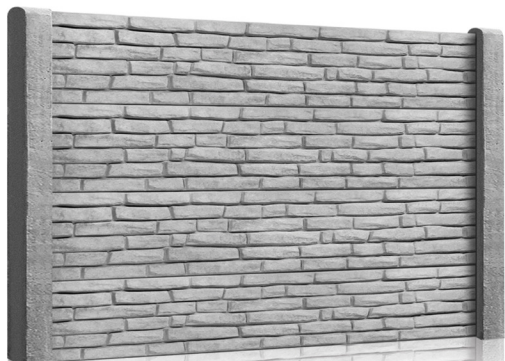

CHISELED
(SKU# B-023)

COLORS



Natural



White



Charcoal



Buff



Toffee



Brown



Earth



Red



Weave (Natural) / Weave Lattice

THE
STACK WALL
COLLECTION

ELABORATE

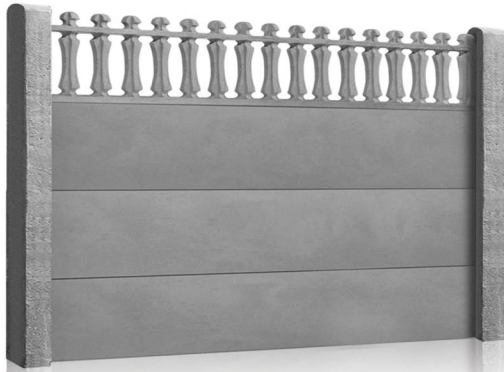

NEPTUNE
(SKU# E-006)



NAPA
(SKU# E-008)



VINEYARD
(SKU# E-009)

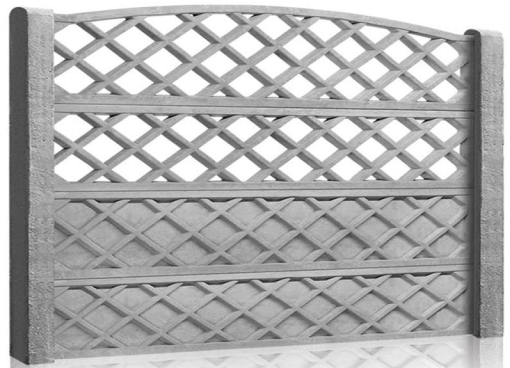

WEAVE
(SKU# E-011)



BOMBAY
(SKU# E-012)

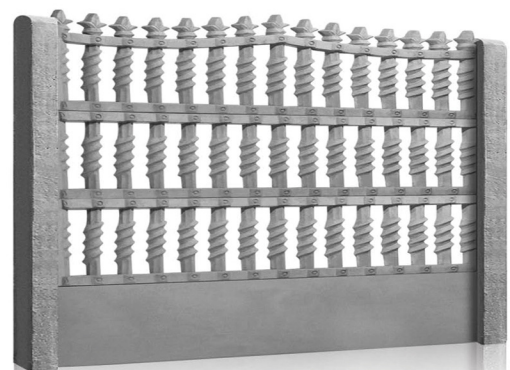

IRON TWIST
(SKU# E-013)

COLORS



Natural



White



Charcoal



Buff



Toffee



Brown



Earth



Red



Cottage (White)

THE
STACK WALL
COLLECTION

PICKET

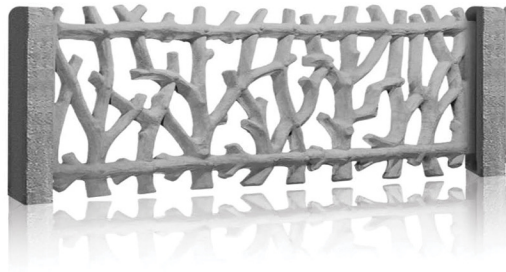

THICKET
(SKU# P-003)

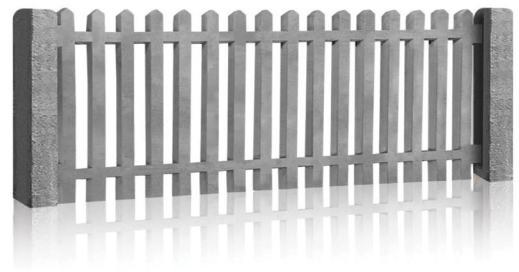

THE TRADITIONAL
(SKU# P-005)

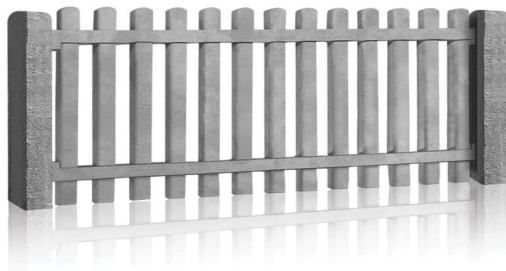

CALIFORNIA
(SKU# P-006)

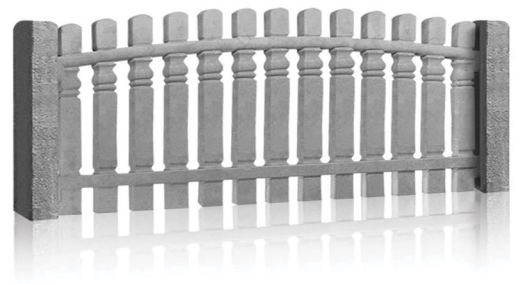

TURNUED
(SKU# P-007)

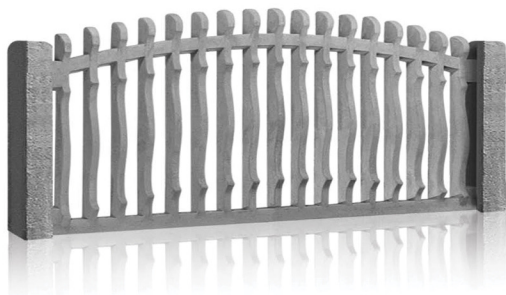

COTTAGE
(SKU# P-008)

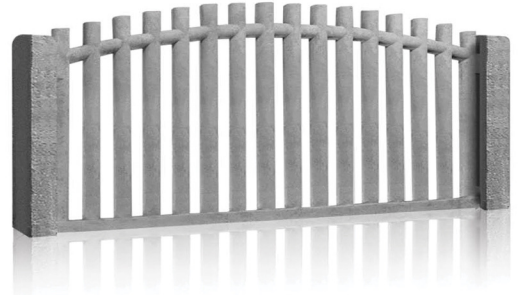

ARCHED
(SKU# P-009)

COLORS



Natural



White



Charcoal



Buff



Toffee



Brown



Earth



Red

We deliver & install nationwide. No project is too big or too small. Our project list includes -

Commercial Projects



Industrial & City Projects



Residential & HOA Projects



StackWall installation process is as easy as one, two, three...

1. We dig holes for foundations.



2. We pour concrete to set posts.



3. We stack to your height.



StackWall vs The Elements -



2 hour fire rated walls



Wind rated 110 MPH minimum



Made from eco-friendly materials



Noise reduction solution



Curb appeal/ raises value



Turnkey ready



Maintenance free

We Work With -

Architects

Will appreciate our wide variety of over 100 designs to choose from.

Contractors

Can count on us for faster turnkey installations.

Engineers

Can rest assured that our seismic, wind-load & soil retention capabilities meet all requirements.

Developers

Spend less time & money for a more aesthetically pleasing outcome on any given property.

Homeowners

Add property value with beautiful, secure & maintenance free walls & fences to match any style.



StackWall incorporates V-Rod fiberglass rebar to every wall made.

V-Rod contains the structural integrity of steel rebar, minus the corrosion, so your wall will last a lifetime.



The StackWall Difference

Our precast concrete fences are handmade & manufactured with sustainable materials, making our walls a perfect contender when it comes to the elements. Whether it be wind, fire, snow, or noise reduction, StackWall blocks out the competition, making it the best protective investment for your home, business or property. The StackWall difference is security with a handmade aesthetic. Sit back & relax, while we precast.



Stackwall Specifications

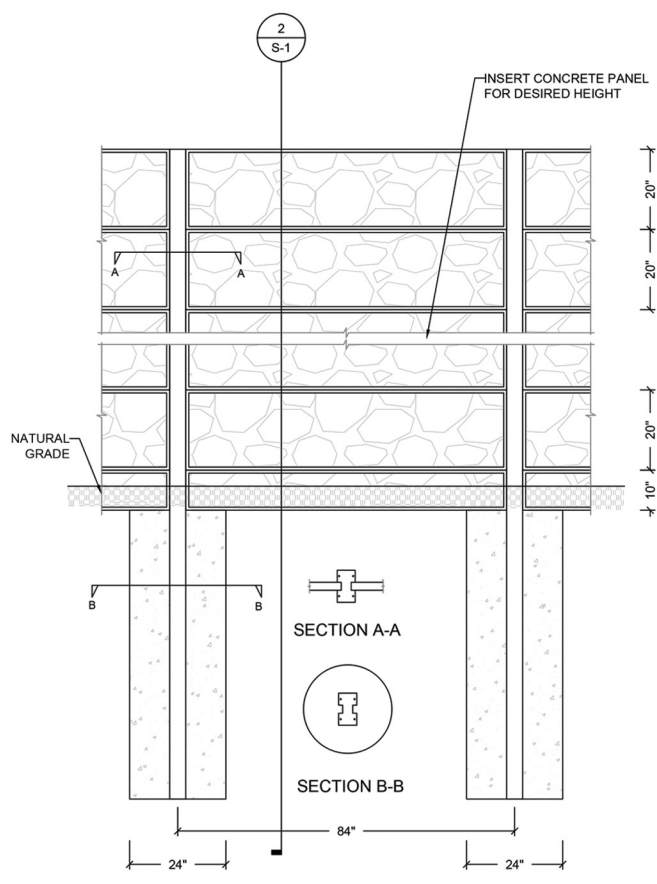

1 PANEL REINFORCING ELEVATION
SCALE: $\frac{1}{2}''=1'-0''$

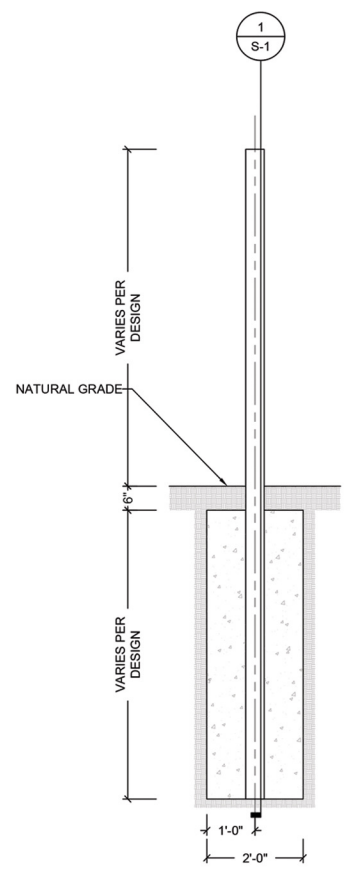

2 FENCE SECTION
SCALE: $\frac{1}{2}''=1'-0''$

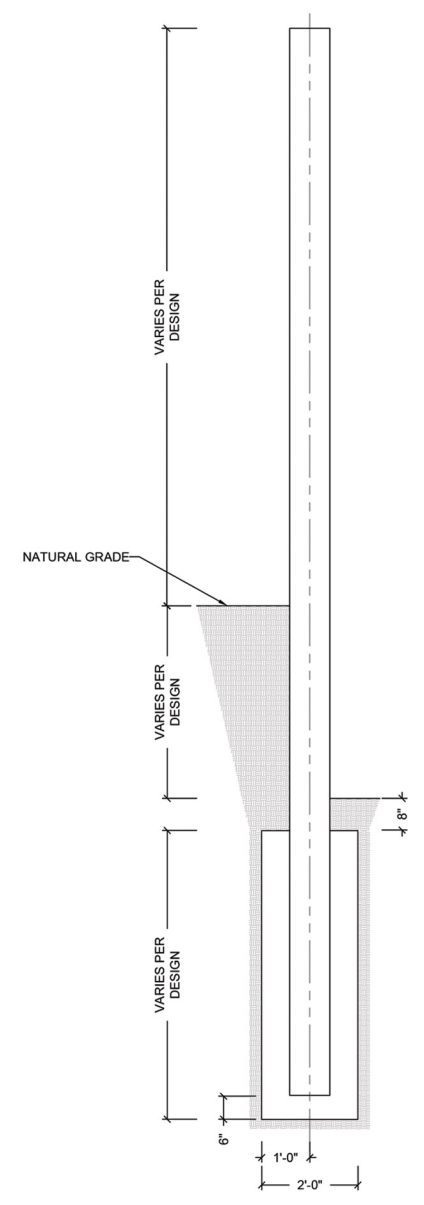

3 FENCE SECTION
SCALE: $\frac{1}{2}''=1'-0''$

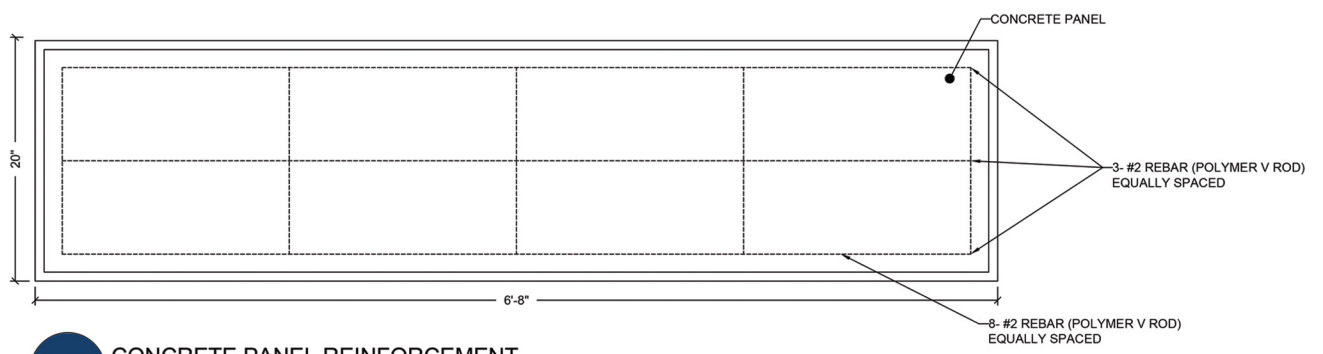

12 CONCRETE PANEL REINFORCEMENT
SCALE: $1 \frac{1}{2}''=1'-0''$



DESIGNED BY: S.S.
CHECKED BY: A.A.

PREPARED FOR:
STACKWALL

PROJECT ADDRESS:
149 S. SAN ANTONIO AVE
POMONA, CA
91766

REV	DATE	DESCRIPTION	BY
1			
2			
3			
4			
5			

STACKWALL

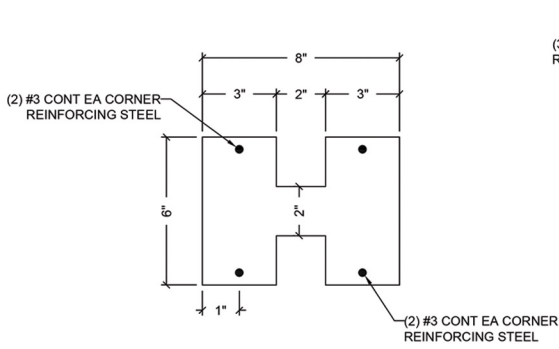

4 COLUMN SECTION 6x8
SCALE: 3"=1'-0"

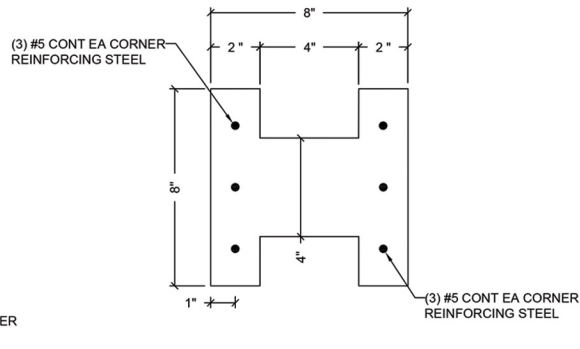

8 COLUMN SECTION 8x8
SCALE: 3"=1'-0"

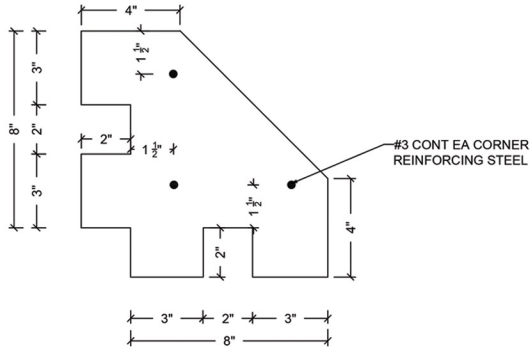

5 CORNER COLUMN SECTION 6x8
SCALE: 3"=1'-0"

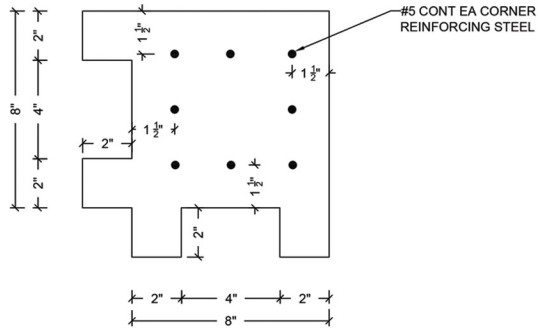

9 CORNER COLUMN SECTION 8x8
SCALE: 3"=1'-0"

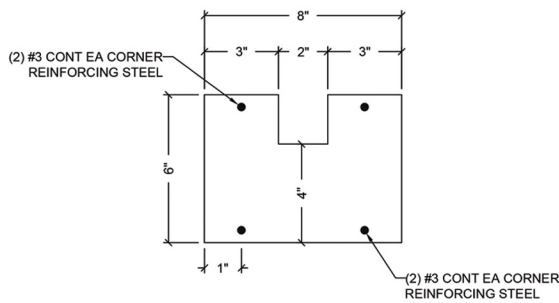

6 END COLUMN SECTION 6x8
SCALE: 3"=1'-0"

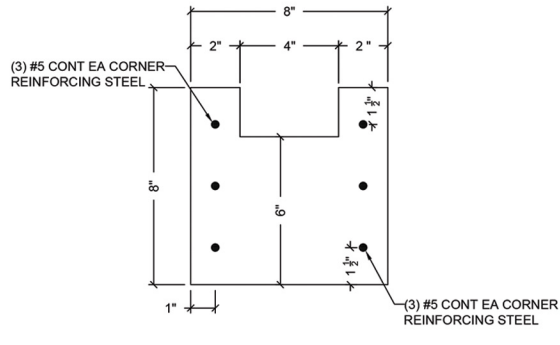

10 END COLUMN SECTION 8x8
SCALE: 3"=1'-0"

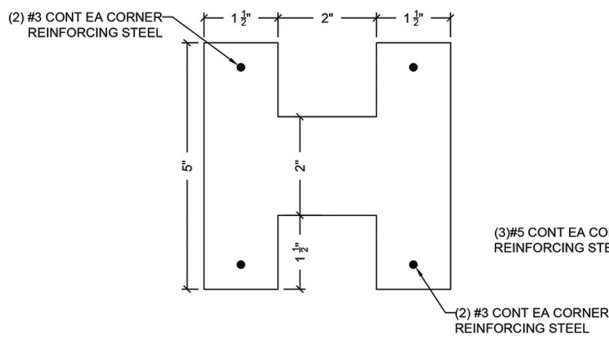

7 COLUMN SECTION 5x5
SCALE: 6"=1'-0"

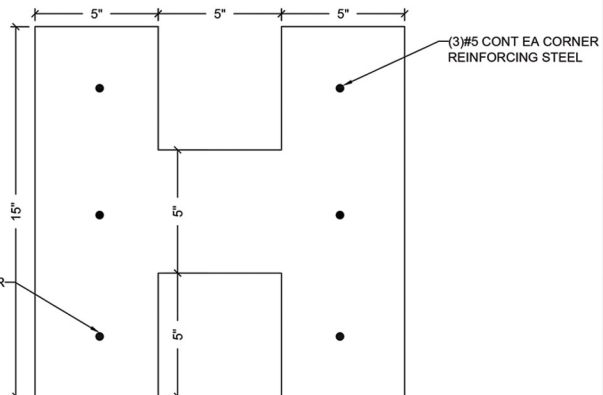

11 COLUMN SECTION 15x15
SCALE: 3"=1'-0"



STACK WALL

WE PRECAST, SO YOU CAN RELAX.

149 S. San Antonio Ave. Pomona, CA 91766
E-mail: info@stackwall.com / Office: 909.397.5350

STACKWALL.COM

MADE IN USA



GO GREEN

