

Full Wall Section - Front View

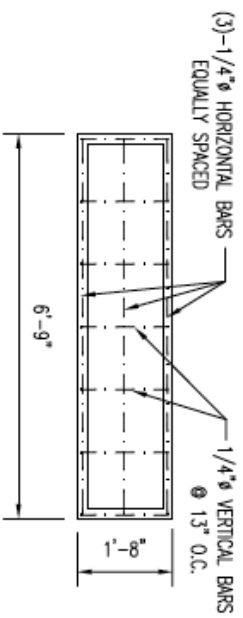

Typical Panel Reinforcement

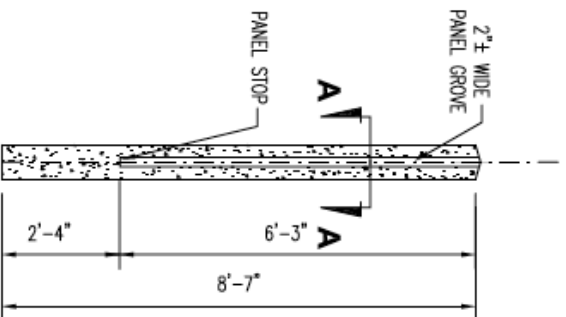

Concrete Post

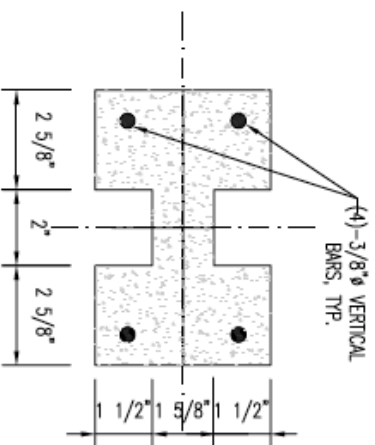

Section A-A



Custom
Stacked
Fencing

149 South San Antonio Avenue,
Pomona, California 91768 USA

Pic: Toll Free 1 (888) 622-9255
1 (909) 397-5350

Fax: 1 (909) 397-5352

www.stackwall.com

PROJECT INFORMATION

Name: Stackwall Fence
Number: 22, 105, 105, 105
Type: Full Wall
Location: Various California

ZONING SET SUBMITTAL	BLDG DEPT SET SUBMITTAL	ISSUE SET SUBMITTAL

REV	DATE	DESCRIPTION

Drawn by: L. Krasuski, P.E.
Approved by: R. Maniko

File Number	Print Date
21-2010	2010-04-02

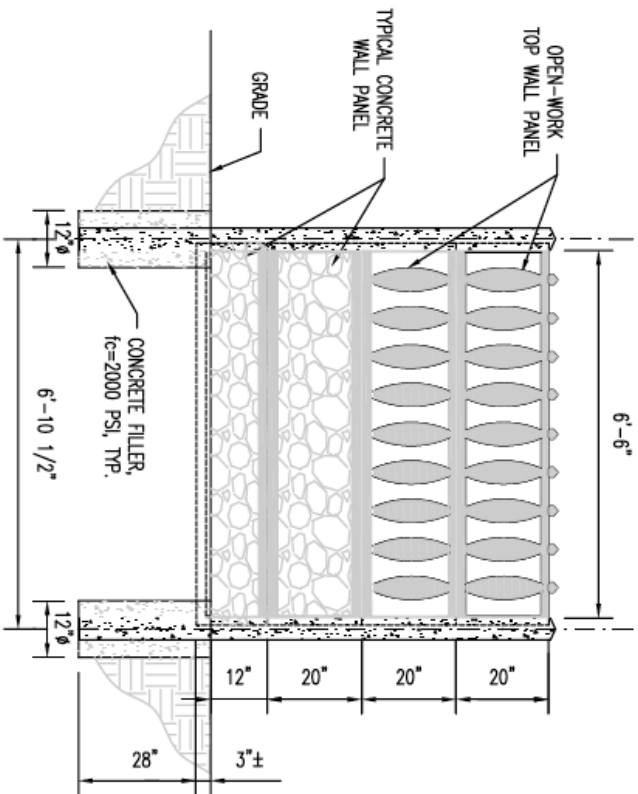

Decorative Wall Section - Front View

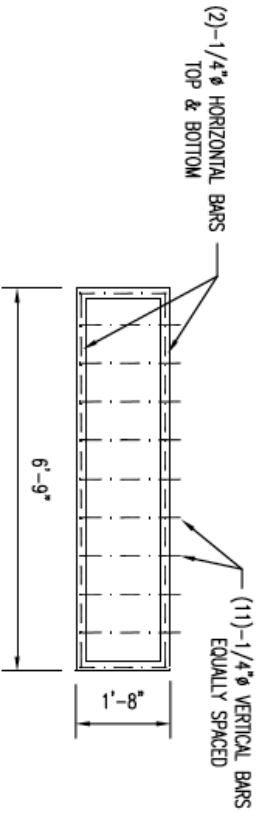

Typical Open-work Panel Reinforcement

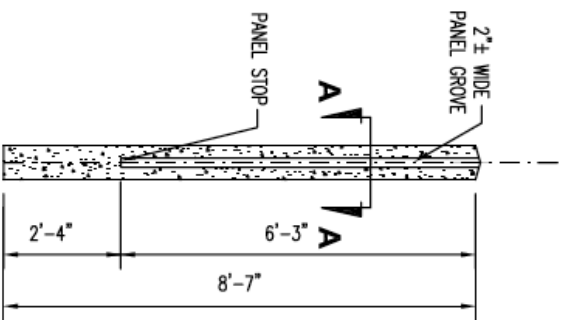

Concrete Post

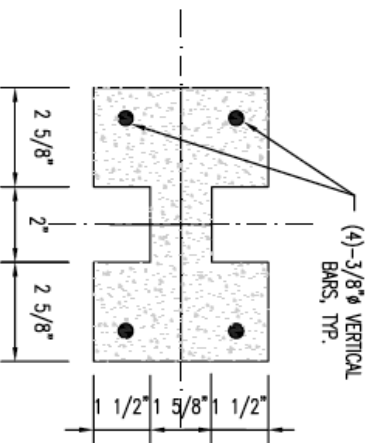

Section A-A

STACK WALL
W.COM WALL

Custom
Stacked
Fencing

149 South San Antonio Avenue,
Pomona, California 91766 USA

Ph: Toll Free 1 (888) 622-9255
1 (909) 397-5350

Fax: 1 (909) 397-5352

www.stackwall.com

PROJECT INFORMATION

Name: **Stackwall Fence**
Number: 95, 5, 105, 105
Type: Art-Work Wall
Location: Various California

ZONING SET SUBMITTAL
BLDG DEPT. SET SUBMITTAL
INSUR SET SUBMITTAL

REV	DATE	DESCRIPTION

Drawn by: L. Krasuski, P.E.
Approved by: R. Maniko

Form Number	Print Date
19-2010	2010-03-31